

## PRODUCT INFO

# GENERAL PURPOSE ROUTER BIT SET

## EY12SET

12<sub>PC</sub>



### DESCRIPTION

The Econocut 12pc General Purpose Router Bit Set is a must-have for any handyman or DIY enthusiast. This set includes the 12 most popular router bits, ensuring you have the right tool for various woodworking tasks. The bits are neatly organized in an attractive timber window box that offers excellent storage convenience. With a rotating bit holder, accessing the desired bit becomes a breeze. Featuring a 1/4" shank, which is highly favored among DIY users, all the bits provide a smoother cutting action with their two-flute design. As a bonus, this set includes the EZE-LAP™ Diamond Sharpener, with a fine 600-grit abrasive, perfect for all general sharpening needs with precision and ease.

### CONTENTS

- 3 x Straight Bits
- 1 x Core Box Bit
- 1 x 14° Dovetail Bit
- 1 x 90° V-Groove Bit
- 1 x Flush Trim Bit with Bearing
- 2 x Rounding Over Bits with Bearing
- 1 x Cove bit with Bearing
- 1 x 45° Chamfering Bit with Bearing
- 1 x Roman Ogee Bit with Bearing
- 1 x Bonus EZE-LAP™ Diamond Hone & Stone Sharpener



**BARCODE:** 9314350047839

**ROUTER BIT SHANK:** 1/4"

**BOX LENGTH:** 205mm

**BOX WIDTH:** 160mm

**BOX DEPTH:** 50mm

**SHARPENER:** 150 x 20 x 5mm

**QUANTITY:** 12pc set

**WEIGHT:** 679g

## MEASUREMENTS

# GENERAL PURPOSE ROUTER BIT SET EY12SET

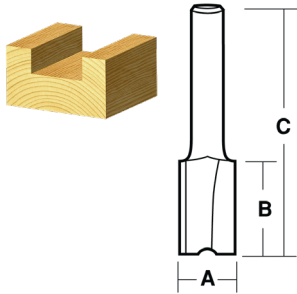

### STRAIGHT BIT

SHANK	RADIUS (R)	DIAMETER (A)	CUTTING LENGTH (B)	OVERALL LENGTH (C)	FLUTES	MAX SPEED (RPM)	WEIGHT
1/4" (6.35mm)	---	6mm	16mm	46.7mm	2	24000	10g
1/4" (6.35mm)	---	12mm	20mm	51.7mm	2	24000	18g
1/4" (6.35mm)	---	16mm	20mm	51.7mm	2	24000	24g

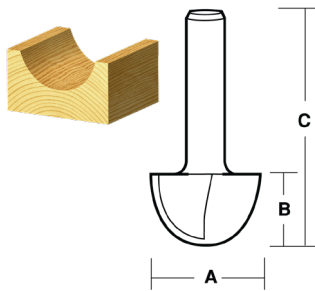

### CORE BOX BIT

SHANK	RADIUS (R)	DIAMETER (A)	CUTTING LENGTH (B)	OVERALL LENGTH (C)	FLUTES	MAX SPEED (RPM)	WEIGHT
1/4" (6.35mm)	6.35mm	12.7mm	9.5mm	40mm	2	24000	11g

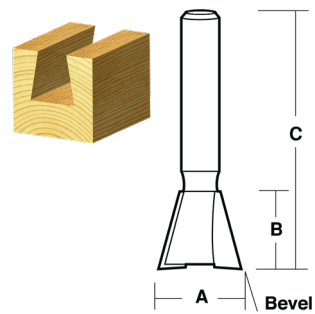

### DOVETAIL BIT

SHANK	ANGLE	DIAMETER (A)	CUTTING LENGTH (B)	OVERALL LENGTH (C)	FLUTES	MAX SPEED (RPM)	WEIGHT
1/4" (6.35mm)	14°	14.3mm	12.7mm	45mm	2	24000	11g

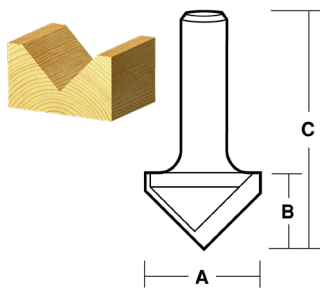

### V-GROOVE BIT

SHANK	ANGLE	DIAMETER (A)	CUTTING LENGTH (B)	OVERALL LENGTH (C)	FLUTES	MAX SPEED (RPM)	WEIGHT
1/4" (6.35mm)	90°	12.7mm	12.7mm	45mm	2	24000	13g

## MEASUREMENTS

# GENERAL PURPOSE ROUTER BIT SET EY12SET

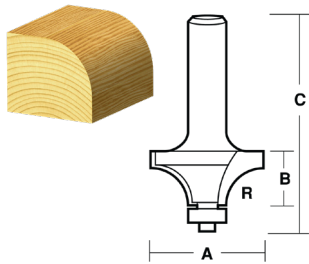

### ROUNDING OVER BIT WITH BEARING

SHANK	RADIUS (R)	DIAMETER (A)	CUTTING LENGTH (B)	OVERALL LENGTH (C)	FLUTES	MAX SPEED (RPM)	WEIGHT
1/4" (6.35mm)	6.35mm	25.4mm	13.5mm	52mm	2	24000	38g
1/4" (6.35mm)	9.5mm	31.8mm	16.5mm	56mm	2	18000	53g

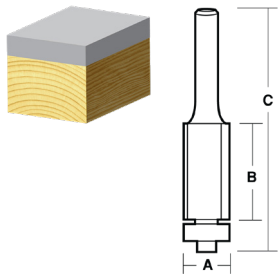

### FLUSH TRIM BIT WITH BEARING

SHANK	RADIUS (R)	DIAMETER (A)	CUTTING LENGTH (B)	OVERALL LENGTH (C)	FLUTES	MAX SPEED (RPM)	WEIGHT
1/4" (6.35mm)	---	12.7mm	13mm	56mm	2	24000	20g

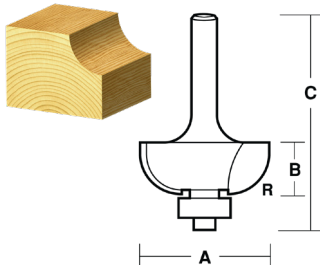

### COVE BIT WITH BEARING

SHANK	RADIUS (R)	DIAMETER (A)	CUTTING LENGTH (B)	OVERALL LENGTH (C)	FLUTES	MAX SPEED (RPM)	WEIGHT
1/4" (6.35mm)	6.35mm	22mm	13mm	52mm	2	24000	31g

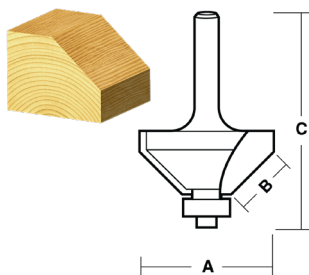

### CHAMFERING BIT WITH BEARING

SHANK	RADIUS (R)	DIAMETER (A)	CUTTING LENGTH (B)	OVERALL LENGTH (C)	FLUTES	MAX SPEED (RPM)	WEIGHT
1/4" (6.35mm)	---	32mm	15mm	55mm	2	18000	47g

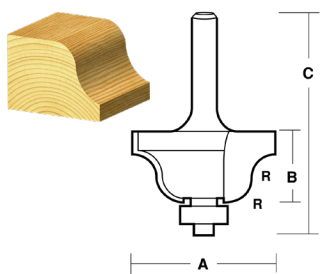

### ROMAN OGEE BIT WITH BEARING

SHANK	RADIUS (R)	DIAMETER (A)	CUTTING LENGTH (B)	OVERALL LENGTH (C)	FLUTES	MAX SPEED (RPM)	WEIGHT
1/4" (6.35mm)	4mm	25.5mm	13mm	52mm	2	24000	32g